

HIGH EFFICIENCY RECTIFIER

Table 1: Main Product Characteristics

$I_{F(AV)}$	10 A
V_{RRM}	300 V
$t_{rr} (typ)$	13 ns
T_j	175°C
$V_F (typ)$	0.9 V

FEATURES AND BENEFITS

- Ultrafast recovery
- Low power losses
- High surge capability
- Low leakage current
- High junction temperature

DESCRIPTION

The **STTH1003S** is an Ultrafast Recovery Power Rectifier dedicated to **energy recovery in PDP application**.

It is especially designed for clamping function in energy recovery block.

The compromise between forward voltage drop and recovery time offer optimized performances.

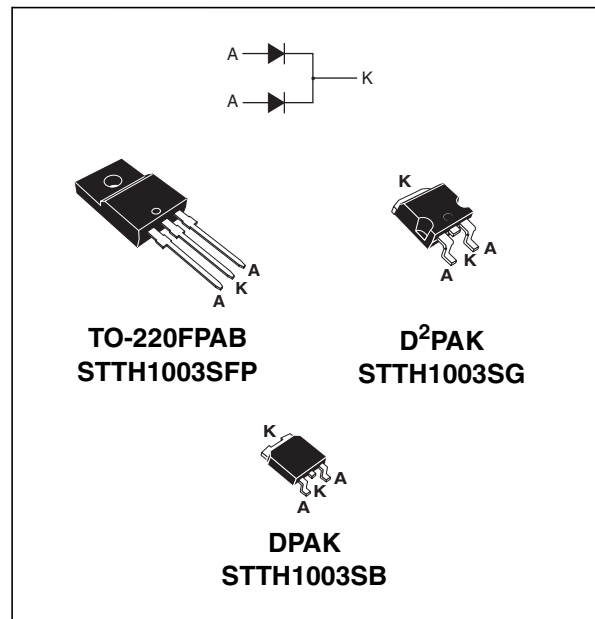

Table 2: Order Codes

Part Numbers	Marking
STTH1003SFP	STTH1003SFP
STTH1003SB	STTH1003SB
STTH1003SB-TR	STTH1003SB
STTH1003SG	STTH1003SG
STTH1003SG-TR	STTH1003SG

Table 3: Absolute Ratings (limiting values)

Symbol	Parameter	Value	Unit
V_{RRM}	Repetitive peak reverse voltage	300	V
$I_{F(RMS)}$	RMS forward voltage	20	A
$I_{F(AV)}$	Average forward current	$T_c = 150^\circ\text{C} \quad \delta = 0.5$	A
I_{FSM}	Surge non repetitive forward current	$t_p = 10\text{ms sinusoidal}$	A
I_{RSM}	Non repetitive avalanche current	$t_p = 20 \mu\text{s square}$	A
T_{stg}	Storage temperature range	-65 to + 175	°C
T_j	Maximum operating junction temperature	175	°C

Table 4: Thermal Parameters

Symbol	Parameter	Package	Value	Unit
R _{th(j-c)}	Junction to case	DPAK	4	°C/W
		D ² PAK	4	
		TO220FP	6	

Table 5: Static Electrical Characteristics

Symbol	Parameter	Test conditions		Min.	Typ	Max.	Unit
I _R *	Reverse leakage current	T _j = 25°C	V _R = V _{RRM}			10	μA
		T _j = 125°C			10	100	
V _F **	Forward voltage drop	T _j = 25°C	I _F = 10A			1.30	V
		T _j = 125°C			0.9	1.1	

Pulse test: * tp = 5 ms, δ < 2%

** tp = 380 μs, δ < 2%

To evaluate the conduction losses use the following equation: $P = 0.86 \times I_{F(AV)} + 0.024 I_F^2 (RMS)$

Table 6: Recovery Characteristics

Symbol	Parameter	Test conditions		Min.	Typ	Max.	Unit
t _{rr}	Reverse recovery time	T _j = 25°C	I _F = 0.5A I _{rr} = 0.25A I _R = 1A		13	17	ns
			I _F = 1A V _R = 30V dI _F /dt = -50 A/μs		28	35	
t _{fr}	Forward recovery time	T _j = 25°C	I _F = 10A dI _F /dt = 100 A/μs V _{FR} = 1.1 x V _{Fmax}			200	ns
I _{RM}	Reverse recovery current	T _j = 125°C	I _F = 10A V _{CC} = 200V dI _F /dt = 200 A/μs		5.7	7.5	A
S _{factor}	Softness factor				0.3		
V _{FP}	Peak forward voltage	T _j = 25°C	I _F = 10A dI _F /dt = 100 A/μs		2.5	3.5	V

Figure 1: Forward voltage drop versus current (maximum values)

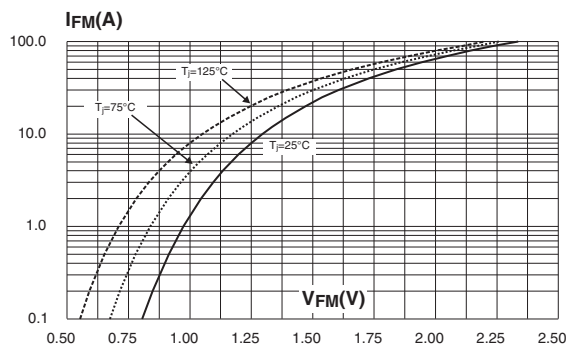

Figure 2: Peak reverse recovery current versus dI_F/dt (90% confidence)

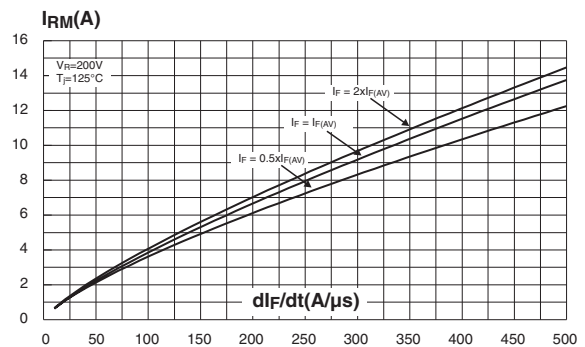

Figure 3: Reverse recovery time versus di_F/dt (90% confidence)

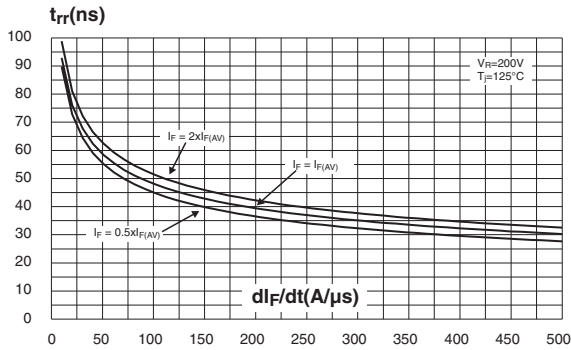

Figure 4: Softness factor versus di_F/dt (typical values)

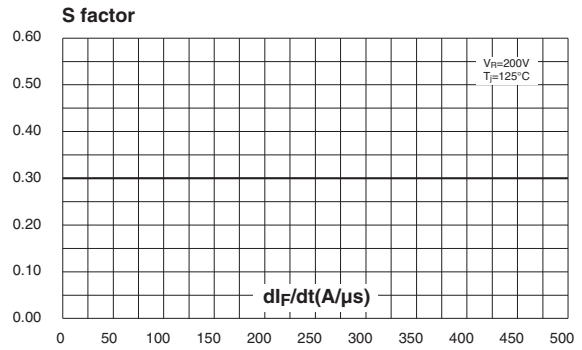

Figure 5: Relative variations of dynamic parameters versus junction temperature (reference: $T_j = 125^\circ C$)

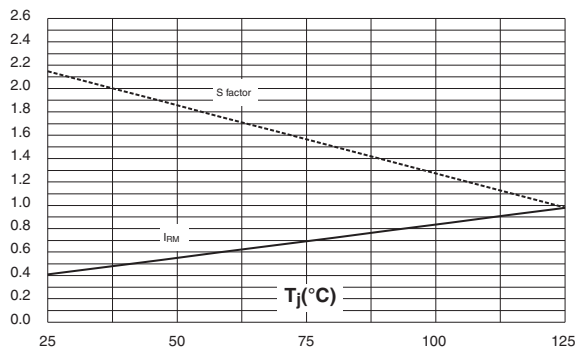

Figure 6: Transient peak forward voltage versus di_F/dt (90% confidence)

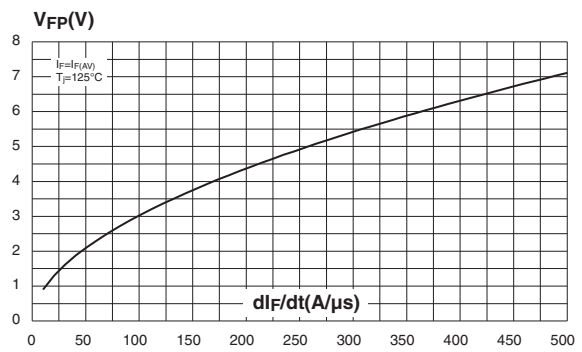

Figure 7: Forward recovery time versus di_F/dt (90% confidence)

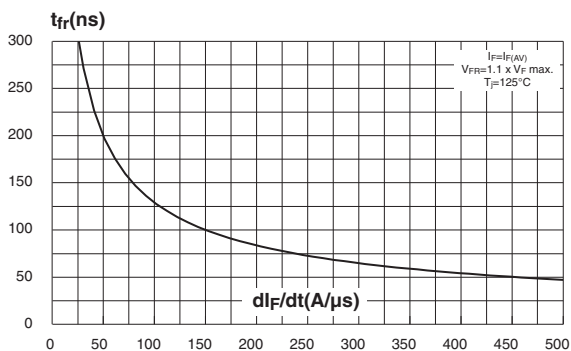

Figure 8: DPAK Package Mechanical Data

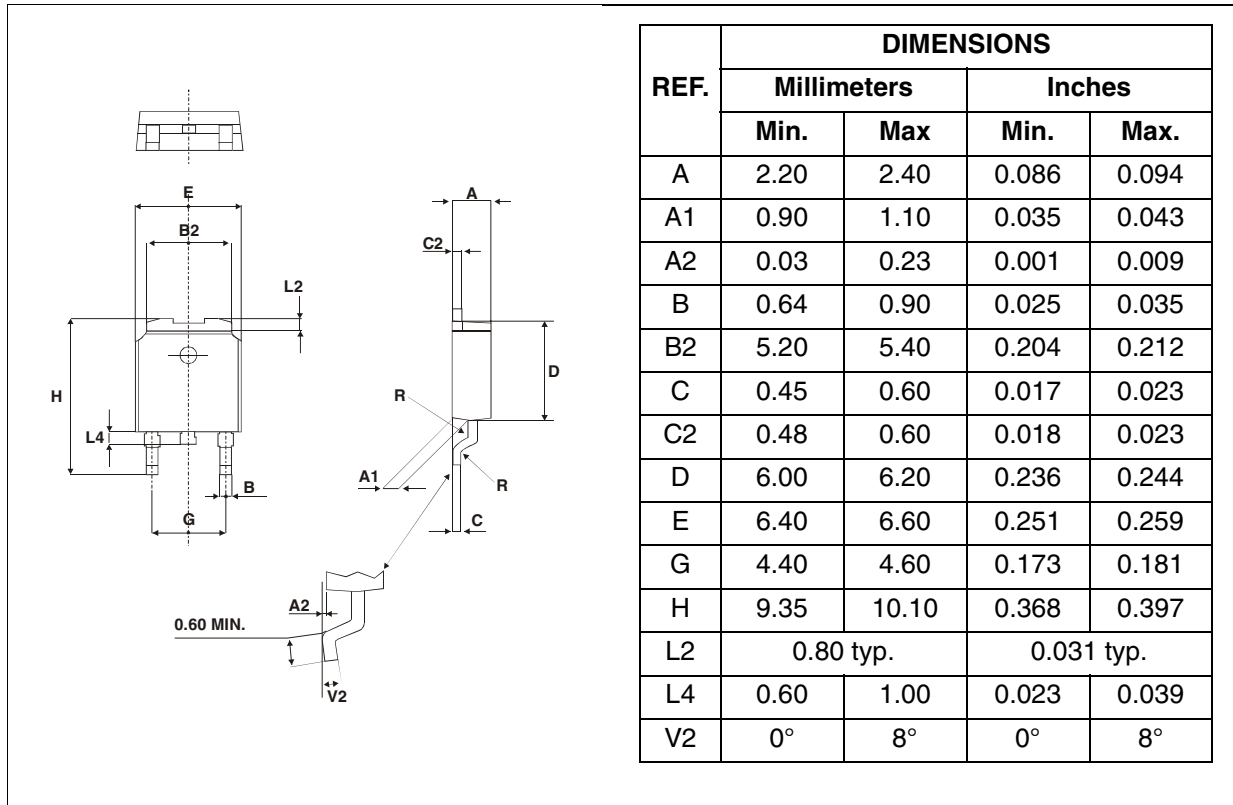

Figure 9: Foot Print dimensions (in millimeters)

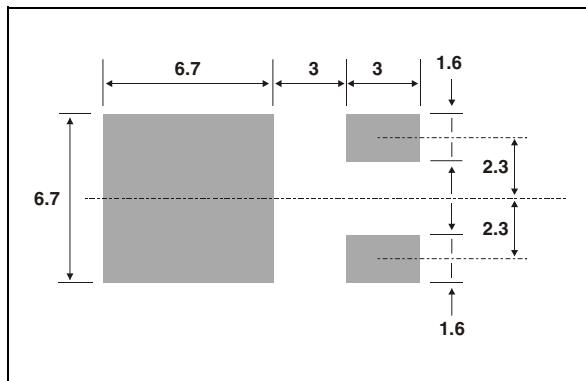

Figure 10: D²PAK Package Mechanical Data

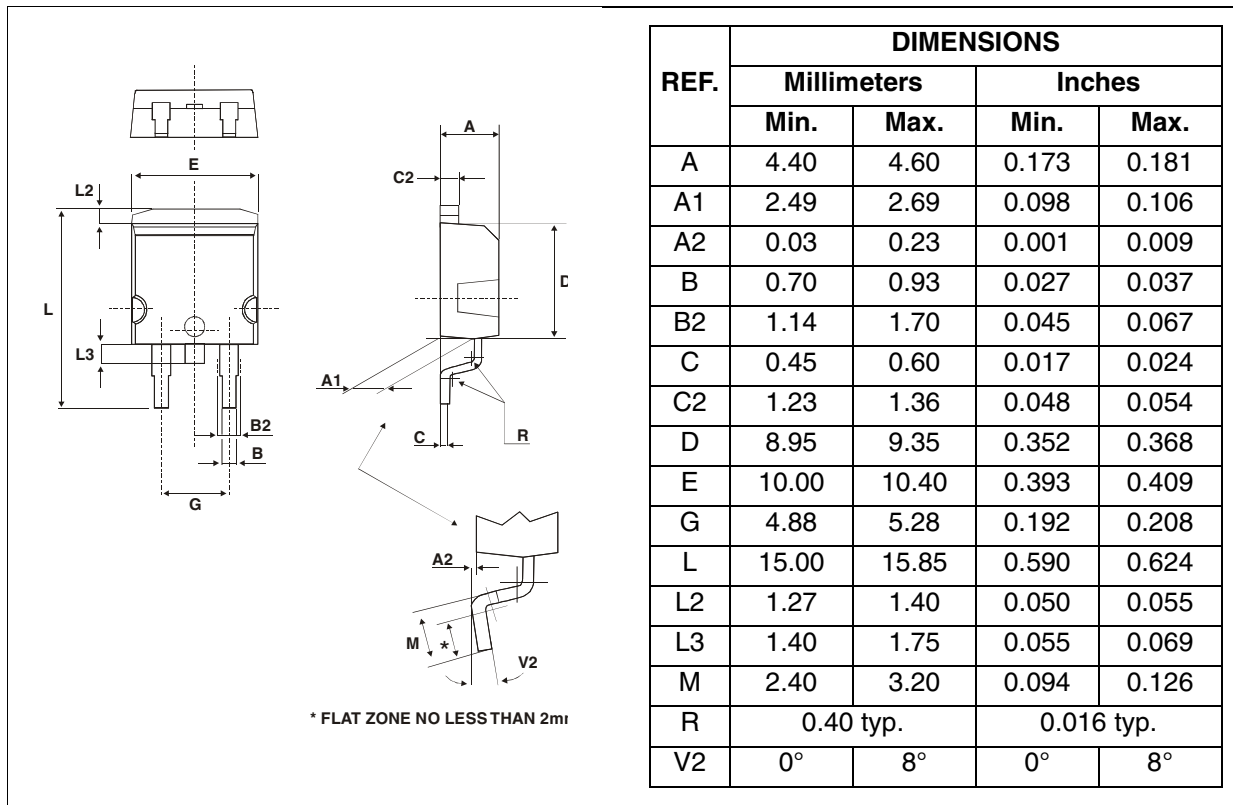

Figure 11: Foot Print dimensions (in millimeters)

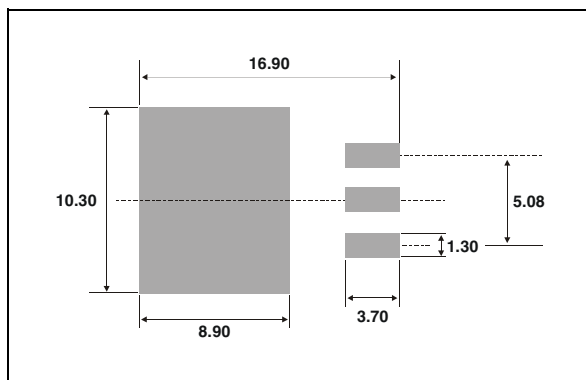
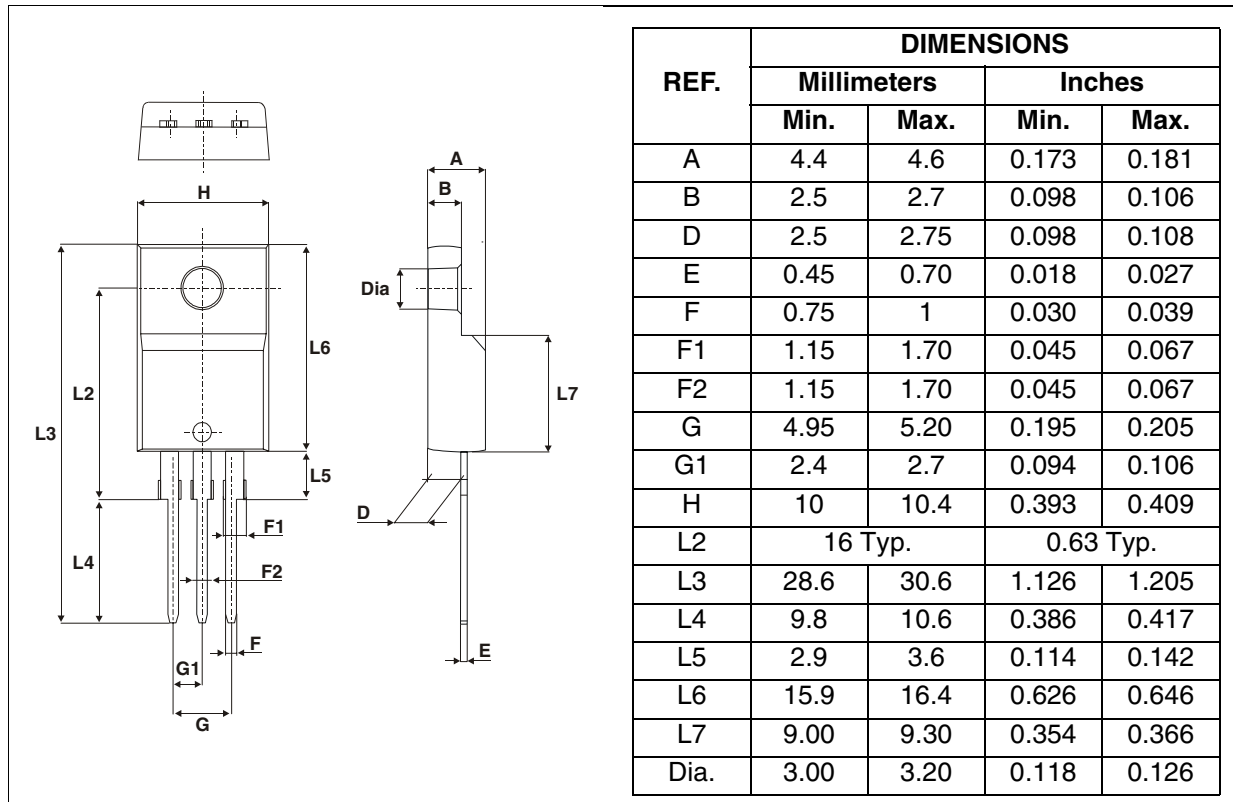

Figure 12: TO-220FPAB Package Mechanical Data



In order to meet environmental requirements, ST offers these devices in ECOPACK® packages. These packages have a Lead-free second level interconnect. The category of second level interconnect is marked on the package and on the inner box label, in compliance with JEDEC Standard JESD97. The maximum ratings related to soldering conditions are also marked on the inner box label. ECOPACK is an ST trademark. ECOPACK specifications are available at: www.st.com.

STTH1003S

Table 7: Ordering Information

Ordering type	Marking	Package	Weight	Base qty	Delivery mode
STTH1003SFP	STTH1003SFP	TO-220FPAB	1.70 g	50	Tube
STTH1003SB	STTH1003SB	DPAK	0.3 g	75	Tube
STTH1003SB-TR	STTH1003SB			2500	Tape & reel
STTH1003SG	STTH1003SG	D ² PAK	1.48 g	50	Tube
STTH1003SG-TR	STTH1003SG			1000	Tape & reel

- Epoxy meets UL94, V0
- Cooling method: by conduction (C)
- Recommended torque value: 0.8 m.N.
- Maximum torque value: 1.0 m.N.

Table 8: Revision History

Date	Revision	Description of Changes
24-Aug-2005	1	First issue.

Information furnished is believed to be accurate and reliable. However, STMicroelectronics assumes no responsibility for the consequences of use of such information nor for any infringement of patents or other rights of third parties which may result from its use. No license is granted by implication or otherwise under any patent or patent rights of STMicroelectronics. Specifications mentioned in this publication are subject to change without notice. This publication supersedes and replaces all information previously supplied. STMicroelectronics products are not authorized for use as critical components in life support devices or systems without express written approval of STMicroelectronics.

The ST logo is a registered trademark of STMicroelectronics.
All other names are the property of their respective owners

© 2005 STMicroelectronics - All rights reserved

STMicroelectronics group of companies

Australia - Belgium - Brazil - Canada - China - Czech Republic - Finland - France - Germany - Hong Kong - India - Israel - Italy - Japan -
Malaysia - Malta - Morocco - Singapore - Spain - Sweden - Switzerland - United Kingdom - United States of America

www.st.com

